

SAVEMAX LIGHTING

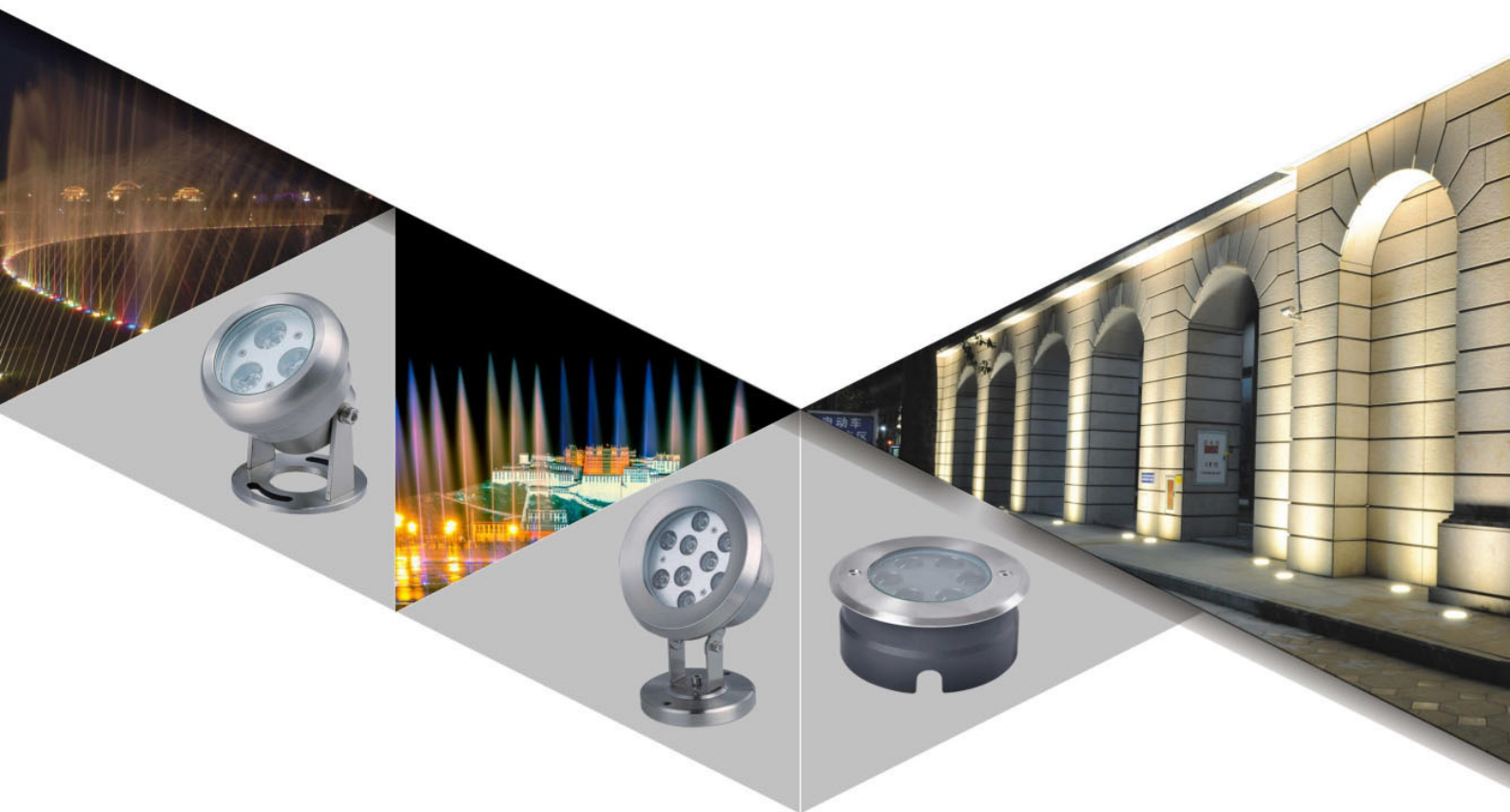

专业水下灯 · 埋地灯照明

Professional underwater light · Buried light lighting



[Http://isavemax.com](http://isavemax.com)

Email: sales@isavemax.com

资质证书 Qualification certificate



MINGGUANG LIGHTING

目录 Contents

LED 不銹鋼水下燈系列 LED Stainless steel underwater lamp	3-18
不銹鋼噴泉燈系列 Stainless steel Underwater lamp series	19-24
泳池壁燈系列 Swimming pool wall lamp series	25-25
接綫盒系列 Junction box series	26-26
LED 水下埋地燈系列 LED underwater buried lamp series	27-39
LED 埋地燈系列 LED Underwater lamp series	40-65
LED 射燈系列 LED Spot lamp series	66-68



不銹鋼水下燈系列

Stainless steel Underwater lamp series

產品說明

- 特點：燈具堅固的結構和嚴格的工藝製造流程，安全性高，使用壽命長，投光距離遠，低碳節能
- 燈具材質：304 不銹鋼配散熱器、高透光性鋼化玻璃、抗老化硅膠密封圈
- 防水等級：IP68
- 控制方式：單控、七彩外控
- 可選顏色：紅、黃、綠、藍、紫、白、暖白、七彩
- 安裝方式：圓盤底座式

Product description

- Characteristics: lamp of solid structure and strict manufacturing process technology, high safety, long service life, low carbon energy saving;
- Lamp of material: 304 stainless steel, high transparent toughened glass, anti-aging silicone seal
- Waterproof level: IP68
- Control mode: single control, multicolor, multicolor external control, DMX512 control of internal control
- Optional colors: red, yellow, green, blue, purple, white, warm white, multicolor

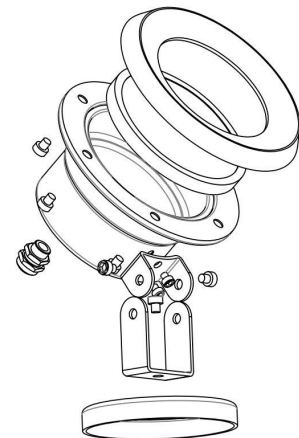

水下燈結構圖

LED 不銹鋼水下燈系列

LED Stainless steel underwater lamp

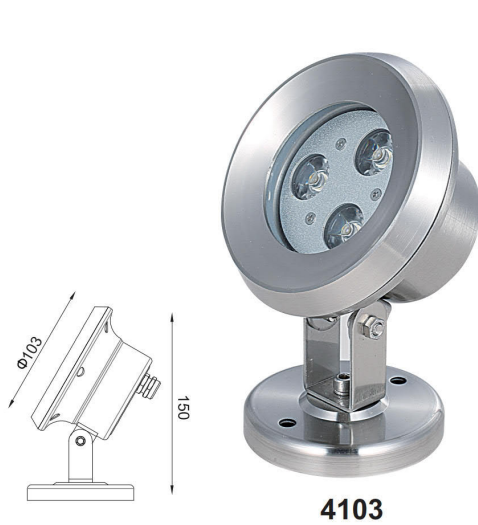

4103

技術參數 (Technical parameter)

適用光源 (Gpls)	LED
功率 (Power)	3W
鋁基板尺寸 (mm)	58
整箱數量 (Ctms)	24
包裝尺寸 (Box size cm)	42*54*32
淨重 kg	0.65KG



4143

技術參數 (Technical parameter)

適用光源 (Gpls)	LED
功率 (Power)	9-12W
鋁基板尺寸 (mm)	98
整箱數量 (Ctms)	18
包裝尺寸 (Box size cm)	53*36*48
淨重 kg	1.3KG



技術參數 (Technical parameter)

適用光源 (Gpls)	LED
功率 (Power)	6-9W
鋁基板尺寸 (mm)	83
整箱數量 (Ctms)	27
包裝尺寸 (Box size cm)	48*48*34
淨重 kg	1KG



4125



4077 浇铸

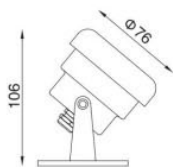

技術參數 (Technical parameter)

適用光源 (Gpls)	LED
功率 (Power)	3W
鋁基板尺寸 (mm)	53
整箱數量 (Ctms)	45
包裝尺寸 (Box size cm)	44*27*36
淨重 kg	0.65KG



4075 浇铸

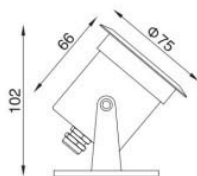

4136

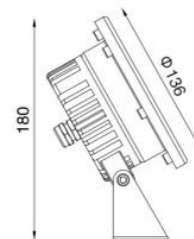

技術參數 (Technical parameter)

適用光源 (Gpls)	LED
功率 (Power)	3W
鋁基板尺寸 (mm)	50
整箱數量 (Ctms)	45
包裝尺寸 (Box size cm)	44*27*36
淨重 kg	0.55KG

技術參數 (Technical parameter)

適用光源 (Gpls)	LED
功率 (Power)	9W
鋁基板尺寸 (mm)	98
整箱數量 (Ctms)	12
包裝尺寸 (Box size cm)	48*33*34
淨重 kg	1.4KG

LED 不銹鋼水下燈系列

LED Stainless steel underwater lamp

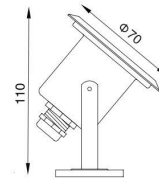

4070

技術參數 (Technical parameter)

適用光源 (Gpls)	LED
功率 (Power)	1-2W
鋁基板尺寸 (mm)	37
整箱數量 (Ctms)	50
包裝尺寸 (Box size cm)	48*48*29
淨重 kg	0.3KG

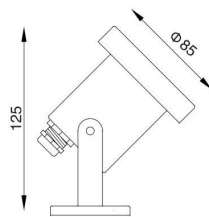

4085-01

技術參數 (Technical parameter)

適用光源 (Gpls)	LED/MR16
功率 (Power)	3W/35W
鋁基板尺寸 (mm)	53
整箱數量 (Ctms)	50
包裝尺寸 (Box size cm)	47*47*29
淨重 kg	0.5KG

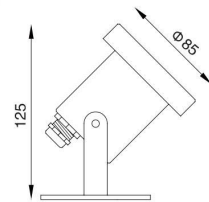

4085-02

技術參數 (Technical parameter)

適用光源 (Gpls)	LED/MR16
功率 (Power)	3W/35W
鋁基板尺寸 (mm)	53
整箱數量 (Ctms)	50
包裝尺寸 (Box size cm)	47*47*29
淨重 kg	0.52KG



4095

技術參數 (Technical parameter)

適用光源 (Gpls)	LED/MR16
功率 (Power)	3W/35W
鋁基板尺寸 (mm)	58
整箱數量 (Ctms)	32
包裝尺寸 (Box size cm)	46*46*37
淨重 kg	0.65KG



4096

技術參數 (Technical parameter)

適用光源 (Gpls)	LED/MR16
功率 (Power)	3W/35W
鋁基板尺寸 (mm)	58
整箱數量 (Ctms)	32
包裝尺寸 (Box size cm)	46*46*37
淨重 kg	0.55KG

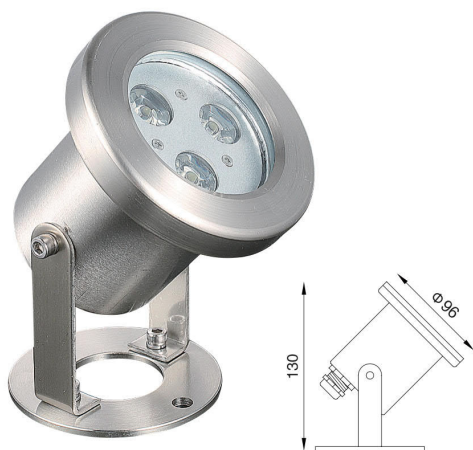

4096-02

技術參數 (Technical parameter)

適用光源 (Gpls)	LED/MR16
功率 (Power)	3W/35W
鋁基板尺寸 (mm)	58
整箱數量 (Ctms)	32
包裝尺寸 (Box size cm)	46*46*37
淨重 kg	0.55KG



4105

技術參數 (Technical parameter)

適用光源 (Gpls)	LED
功率 (Power)	3-5W
鋁基板尺寸 (mm)	57
整箱數量 (Ctms)	32
包裝尺寸 (Box size cm)	46*46*37
淨重 kg	0.55KG

LED 不銹鋼水下燈系列

LED Stainless steel underwater lamp

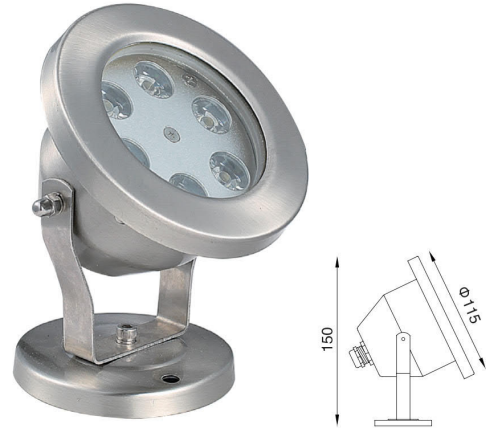

4115-01

技術參數 (Technical parameter)

適用光源 (Gpls)	LED
功率 (Power)	6W
鋁基板尺寸 (mm)	76
整箱數量 (Ctms)	32
包裝尺寸 (Box size cm)	50*50*30
淨重 kg	0.7KG



4115-02

技術參數 (Technical parameter)

適用光源 (Gpls)	LED
功率 (Power)	6W
鋁基板尺寸 (mm)	76
整箱數量 (Ctms)	32
包裝尺寸 (Box size cm)	50*50*30
淨重 kg	0.75KG



4135U

技術參數 (Technical parameter)

適用光源 (Gpls)	LED
功率 (Power)	6-9W
鋁基板尺寸 (mm)	98
整箱數量 (Ctms)	27
包裝尺寸 (Box size cm)	47*47*48
淨重 kg	0.8KG



4145

技術參數 (Technical parameter)

適用光源 (Gpls)	LED
功率 (Power)	9W
鋁基板尺寸 (mm)	112
整箱數量 (Ctms)	27
包裝尺寸 (Box size cm)	47*47*50
淨重 kg	0.9KG



4170U

技術參數 (Technical parameter)

適用光源 (Gpls)	LED
功率 (Power)	12W
鋁基板尺寸 (mm)	120
整箱數量 (Ctms)	18
包裝尺寸 (Box size cm)	52*36*48
淨重 kg	1.2KG



4190U

技術參數 (Technical parameter)

適用光源 (Gpls)	LED
功率 (Power)	15W
鋁基板尺寸 (mm)	140
整箱數量 (Ctms)	12
包裝尺寸 (Box size cm)	42*42*48
淨重 kg	1.5KG



LED 不銹鋼水下燈系列

LED Stainless steel underwater lamp

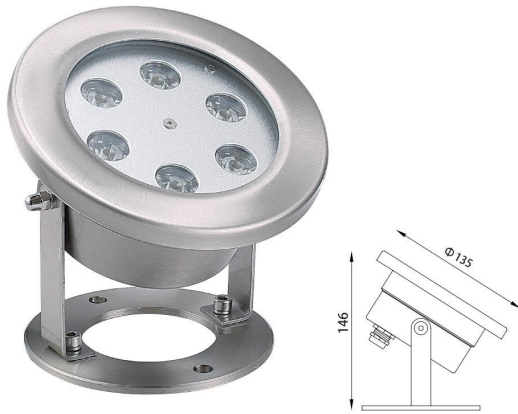

4135 双支架

技術參數 (Technical parameter)

適用光源 (Gpls)	LED
功率 (Power)	6-9W
鋁基板尺寸 (mm)	98
整箱數量 (Ctms)	27
包裝尺寸 (Box size cm)	47*47*48
淨重 kg	0.9KG

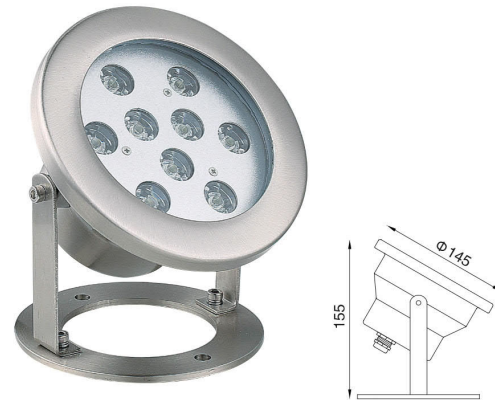

4145 双支架

技術參數 (Technical parameter)

適用光源 (Gpls)	LED
功率 (Power)	9W
鋁基板尺寸 (mm)	112
整箱數量 (Ctms)	27
包裝尺寸 (Box size cm)	47*47*50
淨重 kg	1.1KG



4160-02

技術參數 (Technical parameter)

適用光源 (Gpls)	LED
功率 (Power)	9W
鋁基板尺寸 (mm)	112
整箱數量 (Ctms)	18
包裝尺寸 (Box size cm)	52*37*48
淨重 kg	1.05KG



4160-01

技術參數 (Technical parameter)

適用光源 (Gpls)	LED
功率 (Power)	9W
鋁基板尺寸 (mm)	112
整箱數量 (Ctms)	18
包裝尺寸 (Box size cm)	52*37*48
淨重 kg	1.1KG



4170

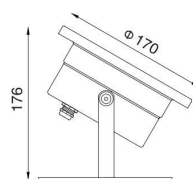

技術參數 (Technical parameter)

適用光源 (Gpls)	LED
功率 (Power)	12W
鋁基板尺寸 (mm)	120
整箱數量 (Ctms)	18
包裝尺寸 (Box size cm)	53*36*48
淨重 kg	1.45KG

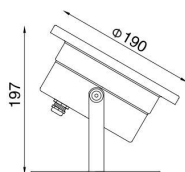
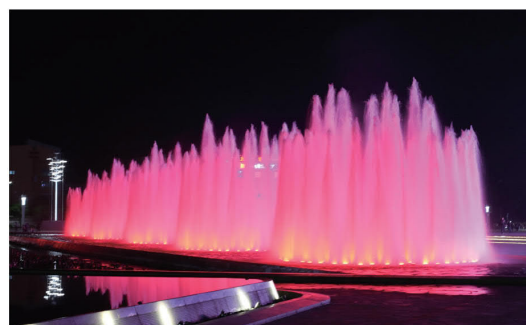

技術參數 (Technical parameter)

適用光源 (Gpls)	LED
功率 (Power)	15W
鋁基板尺寸 (mm)	140
整箱數量 (Ctms)	12
包裝尺寸 (Box size cm)	42*42*48
淨重 kg	1.7KG



4190

LED 不銹鋼水下燈系列

LED Stainless steel underwater lamp



4215

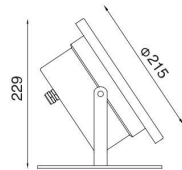

技術參數 (Technical parameter)

適用光源 (Gpls)	LED
功率 (Power)	18W
鋁基板尺寸 (mm)	165
整箱數量 (Ctms)	12
包裝尺寸 (Box size cm)	46*46*50
淨重 kg	2.3KG



4230

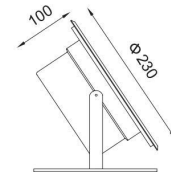

技術參數 (Technical parameter)

適用光源 (Gpls)	LED
功率 (Power)	18W
鋁基板尺寸 (mm)	165
整箱數量 (Ctms)	8
包裝尺寸 (Box size cm)	52*52*37
淨重 kg	2.45KG



4240

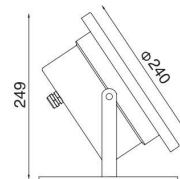

技術參數 (Technical parameter)

適用光源 (Gpls)	LED
功率 (Power)	24W
鋁基板尺寸 (mm)	183-188
整箱數量 (Ctms)	8
包裝尺寸 (Box size cm)	52*52*37
淨重 kg	2.7KG



4250

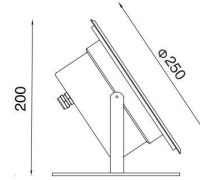

技術參數 (Technical parameter)

適用光源 (Gpls)	LED
功率 (Power)	24W
鋁基板尺寸 (mm)	183-188
整箱數量 (Ctms)	8
包裝尺寸 (Box size cm)	52*52*37
淨重 kg	2.8KG

產品說明

- 特點：燈具堅固的結構和嚴格的工藝制造流程，安全性高，使用壽命長，投光距離遠，低碳節能
- 燈具材質：304 不銹鋼配散熱器、高透光性鋼化玻璃、抗老化硅膠密封圈
- 防水等級：IP68
- 控制方式：單控、七彩外控
- 可選顏色：紅、黃、綠、藍、紫、白、暖白、七彩
- 安裝方式：圓盤底座式

Product description

- Characteristics: lamp of solid structure and strict manufacturing process technology, high safety, long service life, low carbon energy saving;
- Lamp of material: 304 stainless steel, high transparent toughened glass, anti-aging silicone seal
- Waterproof level: IP68
- Control mode: single control, multicolor, multicolor external control, DMX512 control of internal control
- Optional colors: red, yellow, green, blue, purple, white, warm white, multicolor



4300

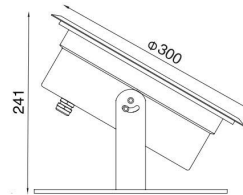

技術參數 (Technical parameter)

適用光源 (Gpls)	LED
功率 (Power)	36W
鋁基板尺寸 (mm)	235
整箱數量 (Ctms)	4
包裝尺寸 (Box size cm)	62*32*38
淨重 kg	3.4KG

LED 不銹鋼水下燈系列

LED Stainless steel underwater lamp



4145 抱箍

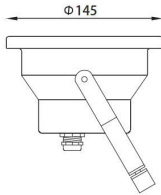

技術參數 (Technical parameter)

適用光源 (Gpls)	LED
功率 (Power)	9W
鋁基板尺寸 (mm)	112
整箱數量 (Ctms)	27
包裝尺寸 (Box size cm)	47*47*50
淨重 kg	0.9KG



4170 抱箍

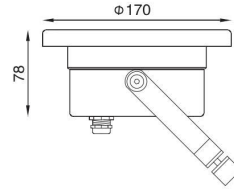

技術參數 (Technical parameter)

適用光源 (Gpls)	LED
功率 (Power)	12W
鋁基板尺寸 (mm)	120
整箱數量 (Ctms)	18
包裝尺寸 (Box size cm)	53*36*48
淨重 kg	1.2KG



4190 抱箍

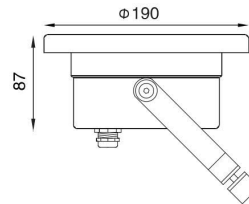

技術參數 (Technical parameter)

適用光源 (Gpls)	LED
功率 (Power)	15W
鋁基板尺寸 (mm)	140
整箱數量 (Ctms)	12
包裝尺寸 (Box size cm)	42*42*48
淨重 kg	1.5KG



4137

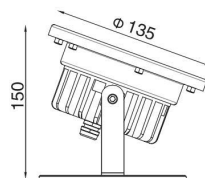

技術參數 (Technical parameter)

適用光源 (Gpls)	LED
功率 (Power)	6-9W
鋁基板尺寸 (mm)	98MM
整箱數量 (Ctms)	18
包裝尺寸 (Box size cm)	48*48*34
淨重 kg	1.2KG



LED 不銹鋼水下燈系列

LED Stainless steel underwater lamp



4161

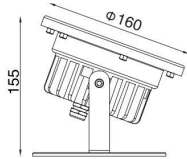

技術參數 (Technical parameter)

適用光源 (Gpls)	LED
功率 (Power)	9W
鋁基板尺寸 (mm)	105
整箱數量 (Ctms)	18
包裝尺寸 (Box size cm)	53*36*48
淨重 kg	1.5KG



4171

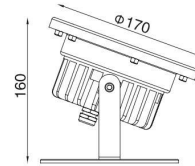

技術參數 (Technical parameter)

適用光源 (Gpls)	LED
功率 (Power)	12W
鋁基板尺寸 (mm)	120
整箱數量 (Ctms)	18
包裝尺寸 (Box size cm)	53*36*48
淨重 kg	1.9KG



4191

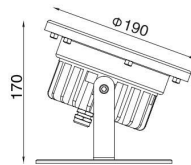

技術參數 (Technical parameter)

適用光源 (Gpls)	LED
功率 (Power)	15-18W
鋁基板尺寸 (mm)	140
整箱數量 (Ctms)	12
包裝尺寸 (Box size cm)	42*42*48
淨重 kg	2.5KG



4216

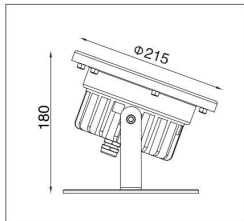

技術參數 (Technical parameter)

適用光源 (Gpls)	LED
功率 (Power)	18-24W
鋁基板尺寸 (mm)	165
整箱數量 (Ctms)	8
包裝尺寸 (Box size cm)	47*47*35
淨重 kg	3.2KG



4241

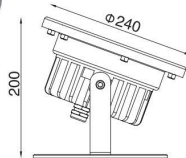

4251

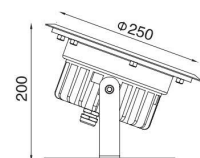

技術參數 (Technical parameter)

適用光源 (Gpls)	LED
功率 (Power)	24-36W
鋁基板尺寸 (mm)	183-188
整箱數量 (Ctms)	8
包裝尺寸 (Box size cm)	52*52*35
淨重 kg	3.8KG

技術參數 (Technical parameter)

適用光源 (Gpls)	LED
功率 (Power)	24-36W
鋁基板尺寸 (mm)	183-188
整箱數量 (Ctms)	8
包裝尺寸 (Box size cm)	52*52*35
淨重 kg	3.9KG

LED 不銹鋼水下燈系列

LED Stainless steel underwater lamp



4301

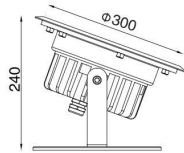

技術參數 (Technical parameter)

適用光源 (Gpls)	LED
功率 (Power)	48W
鋁基板尺寸 (mm)	235
整箱數量 (Ctms)	4
包裝尺寸 (Box size cm)	62*32*38
淨重 kg	6.8KG



4350

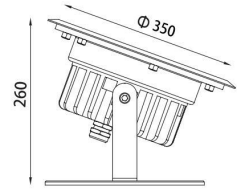

技術參數 (Technical parameter)

適用光源 (Gpls)	LED
功率 (Power)	60W
鋁基板尺寸 (mm)	270
整箱數量 (Ctms)	2
包裝尺寸 (Box size cm)	36*36*44
淨重 kg	10.9KG



4380

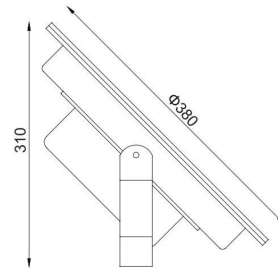

技術參數 (Technical parameter)

適用光源 (Gpls)	LED
功率 (Power)	60W
鋁基板尺寸 (mm)	320MM
整箱數量 (Ctms)	2
包裝尺寸 (Box size cm)	40*40*33
淨重 kg	10.8KG



LED 不銹鋼噴泉燈系列

Stainless steel Underwater lamp series

產品說明

- 特點：燈具堅固的結構和嚴格的工藝製造流程，安全性高，使用壽命長，投光距離遠，低碳節能
- 燈具材質：304 不銹鋼、高透光性鋼化玻璃、抗老化硅膠密封圈
- 防水等級：IP68
- 環境溫度：-20℃—+45℃
- 控制方式：單控、七彩內控、七彩外控、DMX512 控制
- 可選顏色：紅、黃、綠、藍、紫、白、暖白、七彩

Product description

- Characteristics: lamp of solid structure and strict manufacturing process technology, high safety, long service life, low carbon energy saving
- Lamp of material: 304 stainless steel, high transparent toughened glass, anti-aging silicone seal
- Waterproof level: IP68
- Environment temperature: -20℃—+45℃
- Control mode: single control, multicolor, multicolor external control, DMX512 control of internal control
- Optional colors: red, yellow, green, blue, purple, white, warm white, multicolor

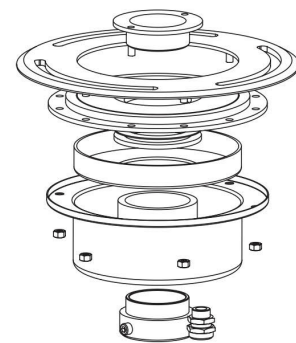

不銹鋼噴泉燈結構圖

LED 不銹鋼噴泉燈系列

Stainless steel Underwater lamp series

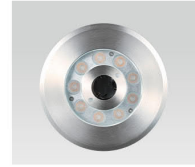
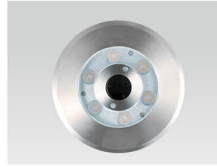
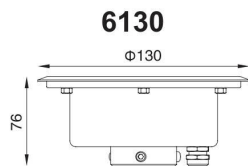

技術參數 (Technical parameter)

中孔 (Aperture) mm	25
功率 (Power)	6-9W
鋁基板尺寸 (mm)	85MM
整箱數量 (Ctms)	18
包裝尺寸 (Box size cm)	47*33*30
淨重 kg	0.9KG

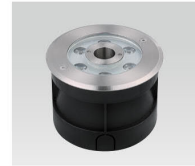
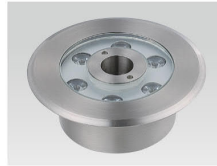
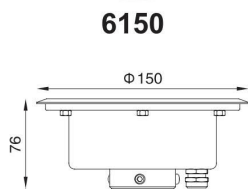

技術參數 (Technical parameter)

中孔 (Aperture) mm	27
功率 (Power)	6-9W
鋁基板尺寸 (mm)	95MM
整箱數量 (Ctms)	18
包裝尺寸 (Box size cm)	47*33*30
淨重 kg	1.0KG

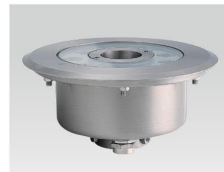
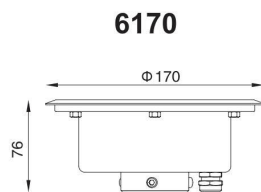

技術參數 (Technical parameter)

中孔 (Aperture) mm	35
功率 (Power)	9W
鋁基板尺寸 (mm)	105
整箱數量 (Ctms)	12
包裝尺寸 (Box size cm)	38.5*38.5*30
淨重 kg	1.3KG



6180

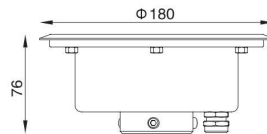

技術參數 (Technical parameter)

中孔 (Aperture) mm	42
功率 (Power)	9-12W
鋁基板尺寸 (mm)	115
整箱數量 (Ctms)	12
包裝尺寸 (Box size cm)	38.5*38.5*30
淨重 kg	1.6KG



6210

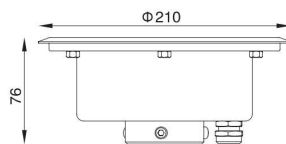

技術參數 (Technical parameter)

中孔 (Aperture) mm	51
功率 (Power)	12-15W
鋁基板尺寸 (mm)	138
整箱數量 (Ctms)	12
包裝尺寸 (Box size cm)	47*47*35
淨重 kg	2.0KG



6230

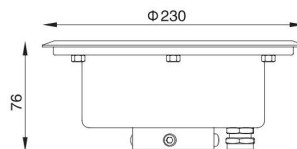

技術參數 (Technical parameter)

中孔 (Aperture) mm	65
功率 (Power)	18W
鋁基板尺寸 (mm)	153
整箱數量 (Ctms)	8
包裝尺寸 (Box size cm)	53*27*50
淨重 kg	2.35kg

LED 不銹鋼噴泉燈系列

Stainless steel Underwater lamp series



6250

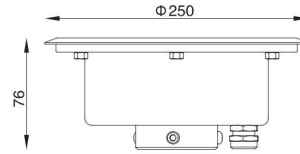

技術參數 (Technical parameter)

中孔 (Aperture) mm	80
功率 (Power)	18-24W
鋁基板尺寸 (mm)	180
整箱數量 (Ctms)	8
包裝尺寸 (Box size cm)	53*27*50
淨重 kg	3.25KG



6300

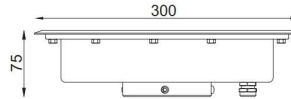

技術參數 (Technical parameter)

中孔 (Aperture) mm	80
功率 (Power)	48W
鋁基板尺寸 (mm)	230
整箱數量 (Ctms)	4
包裝尺寸 (Box size cm)	32*32*52
淨重 kg	4.4KG



6380

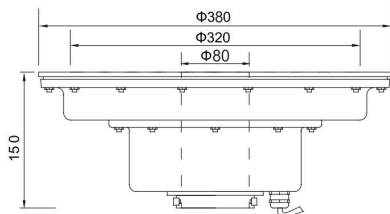

技術參數 (Technical parameter)

中孔 (Aperture) mm	80
功率 (Power)	48-60W
鋁基板尺寸 (mm)	320
整箱數量 (Ctms)	2
包裝尺寸 (Box size cm)	40*40*33
淨重 kg	10.8KG



6135B

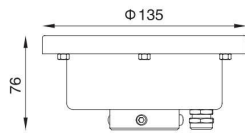

技術參數 (Technical parameter)

中孔 (Aperture) mm	27
功率 (Power)	6-9W
鋁基板尺寸 (mm)	95
整箱數量 (Ctms)	18
包裝尺寸 (Box size cm)	47*33*30
淨重 kg	0.9KG



6160B

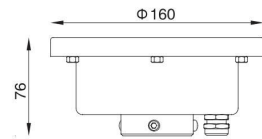

技術參數 (Technical parameter)

中孔 (Aperture) mm	35
功率 (Power)	9W
鋁基板尺寸 (mm)	105
整箱數量 (Ctms)	12
包裝尺寸 (Box size cm)	38.5*38.5*30
淨重 kg	1.15KG



6170B

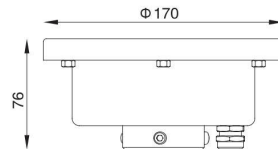

技術參數 (Technical parameter)

中孔 (Aperture) mm	42
功率 (Power)	9-12W
鋁基板尺寸 (mm)	115
整箱數量 (Ctms)	12
包裝尺寸 (Box size cm)	38.5*38.5*30
淨重 kg	1.3KG



LED 不銹鋼噴泉燈系列

Stainless steel Underwater lamp series



6180HS

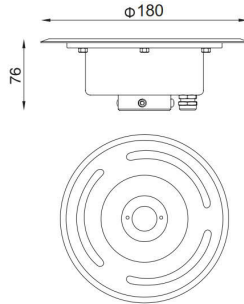

技術參數 (Technical parameter)

中孔 (Aperture) mm	27
功率 (Power)	6-9W
鋁基板尺寸 (mm)	95
整箱數量 (Ctms)	12
包裝尺寸 (Box size cm)	38.5*38.5*30
淨重 kg	1.40KG



6210HS

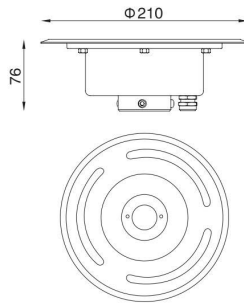

技術參數 (Technical parameter)

中孔 (Aperture) mm	35
功率 (Power)	9W
鋁基板尺寸 (mm)	105
整箱數量 (Ctms)	12
包裝尺寸 (Box size cm)	47*47*35
淨重 kg	1.55KG



6250HS

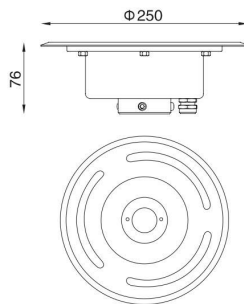

技術參數 (Technical parameter)

中孔 (Aperture) mm	51
功率 (Power)	12-15W
鋁基板尺寸 (mm)	138
整箱數量 (Ctms)	8
包裝尺寸 (Box size cm)	53*28*45
淨重 kg	2.25KG



6280HS

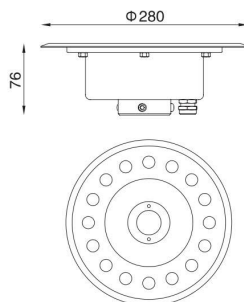

技術參數 (Technical parameter)

中孔 (Aperture) mm	51
功率 (Power)	12-15W
鋁基板尺寸 (mm)	138
整箱數量 (Ctms)	8
包裝尺寸 (Box size cm)	58*58*18
淨重 kg	3.0KG





6230 泳池壁灯

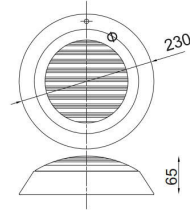

技術參數 (Technical parameter)

適用光源 (Gpls)	LED
功率 (Power)	12W
鋁基板尺寸 (mm)	112
整箱數量 (Ctms)	12
包裝尺寸 (Box size cm)	47*47*36
淨重 kg	0.9KG



6260 泳池壁灯

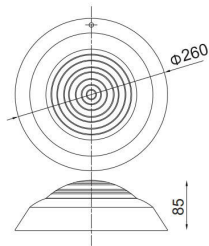

技術參數 (Technical parameter)

適用光源 (Gpls)	LED
功率 (Power)	15W
鋁基板尺寸 (mm)	140
整箱數量 (Ctms)	8
包裝尺寸 (Box size cm)	63*32*51
淨重 kg	1.1KG



6290 泳池壁灯

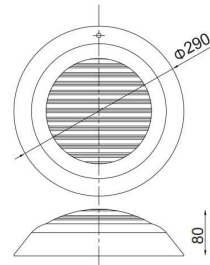

技術參數 (Technical parameter)

適用光源 (Gpls)	LED
功率 (Power)	24W
鋁基板尺寸 (mm)	156
整箱數量 (Ctms)	8
包裝尺寸 (Box size cm)	52*27*50
淨重 kg	1.4KG

型號	材質	適配接頭	最多可配 A 接數量	防護等級
5085	304 不銹鋼	S,A	4	IP68
5115		S,A,B	6	
5145		S,A,B,C,D	10	
5215		S,A,B,C,D	16	



防水接線盒

材質說明

燈體：不銹鋼板料拉深成型，表面光潔、平滑。

緊固件：燈體外觀採用 304 不銹鋼螺絲固定。

密封圈：硅膠密封，防塵防水性能好，耐高溫，抗老化。

產品描述

防護等級：IP68

防護噴塗：表面採用拉絲拋光，燈具內外電泳處理，以提高抗老化防銹防污程度。

產品特性：設計簡約，外形美觀，安裝簡易，照明效果好。

適用場所：水下燈電纜連接防水接線盒（不可放在水中）

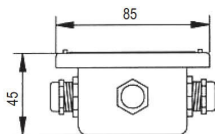

5085

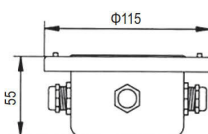

5115

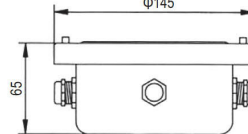

5145

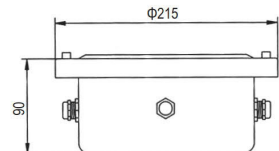

5215



S



A



B



C



D

型號	通線孔直徑	適用電纜直徑	部分國際電纜規格（僅供參考）
S	7.5mm	5.5-7mm	3X0.5 3X1.5
A	10.5mm	7.0-10.0mm	2X1 2X1.5 3X1 3X1.5 4X1
B	13.5mm	10.5-13.0mm	2X2.5 2X4 3X2.5 4X2.5 3X2+1X1.5
C	17.5mm	13.5-17.0mm	2X6 3X4 3X6 4X4 3X4+1X2.5
D	20.5mm	17.5-20.0mm	4X6 3X6+1X4 5X4+1X4



LED 水下埋地燈系列

LED underwater buried lamp series

產品說明

- 特點：燈具堅固的結構和嚴格的工藝製造流程，安全性高，使用壽命長，投光距離遠，低碳節能
- 燈具材質：304 不銹鋼、高透光性鋼化玻璃、抗老化硅膠密封圈
- 防水等級：IP68
- 環境溫度：-20℃—+45℃
- 控制方式：單控、七彩內控、七彩外控、DMX512 控制
- 可選顏色：紅、黃、綠、藍、紫、白、暖白、七彩
- Characteristics: lamp of solid structure and strict manufacturing process technology, high safety, long service life, low carbon energy saving
- Lamp of material: 304 stainless steel, high transparent toughened glass, anti-aging silicone seal
- Waterproof level: IP68
- Environment temperature: -20℃—+45℃
- Control mode: single control, multicolor, multicolor external control, DMX512 control of internal control
- Optional colors: red, yellow, green, blue, purple, white, warm white, multicolor

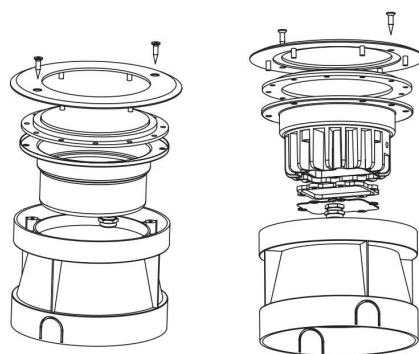

LED 水下埋地燈結構圖

LED 水下埋地燈系列
LED underwater buried lamp series



2070

技術參數 (Technical parameter)

適用光源 (Gpls)	LED
開孔尺寸 (Hole Size)	上 65 下 92
功率 (Power)	1W
鋁基板尺寸 (mm)	37
整箱數量 (Ctms)	50
包裝尺寸 (Box size cm)	48*48*29
淨重 kg	0.25KG

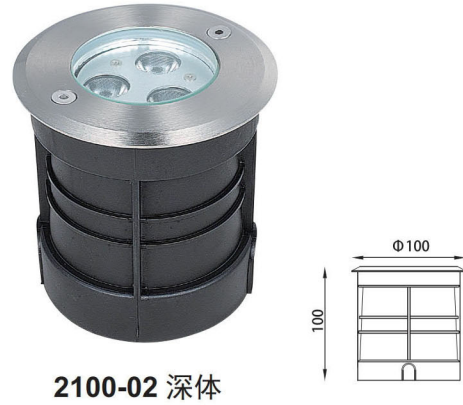

2100-02 深体

技術參數 (Technical parameter)

適用光源 (Gpls)	LED/MR16
開孔尺寸 (Hole Size)	90
功率 (Power)	3W/35W
鋁基板尺寸 (mm)	53
整箱數量 (Ctms)	48
包裝尺寸 (Box size cm)	45*45*38
淨重 kg	0.5KG

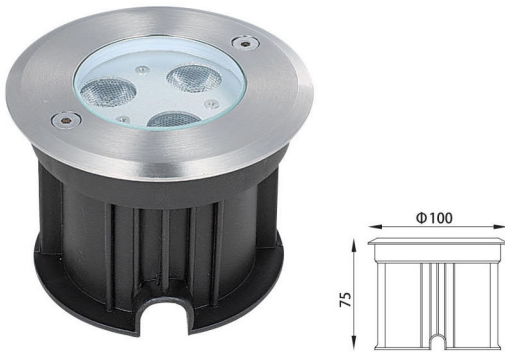

2100-01

技術參數 (Technical parameter)

適用光源 (Gpls)	LED
開孔尺寸 (Hole Size)	90
功率 (Power)	3W
鋁基板尺寸 (mm)	58
整箱數量 (Ctms)	64
包裝尺寸 (Box size cm)	45*45*38
淨重 kg	0.4KG



2120

技術參數 (Technical parameter)

適用光源 (Gpls)	LED/MR16
開孔尺寸 (Hole Size)	102
功率 (Power)	3W/35W
鋁基板尺寸 (mm)	58
整箱數量 (Ctms)	24
包裝尺寸 (Box size cm)	55*42*32
淨重 kg	0.65KG



2130

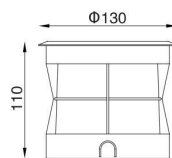

技術參數 (Technical parameter)

適用光源 (Gpls)	LED
開孔尺寸 (Hole Size)	115
功率 (Power)	6W
鋁基板尺寸 (mm)	76
整箱數量 (Ctms)	24
包裝尺寸 (Box size cm)	55*42*32
淨重 kg	0.75KG



2150

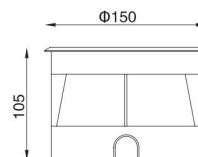

技術參數 (Technical parameter)

適用光源 (Gpls)	LED
開孔尺寸 (Hole Size)	140
功率 (Power)	6-9W
鋁基板尺寸 (mm)	98
整箱數量 (Ctms)	27
包裝尺寸 (Box size cm)	51*51*39
淨重 kg	1KG

技術參數 (Technical parameter)

適用光源 (Gpls)	LED
開孔尺寸 (Hole Size)	150
功率 (Power)	9W
鋁基板尺寸 (mm)	112
整箱數量 (Ctms)	18
包裝尺寸 (Box size cm)	53*37*48
淨重 kg	1.15KG

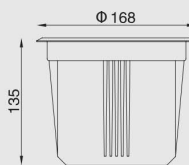

2170

LED 水下埋地燈系列
LED underwater buried lamp series

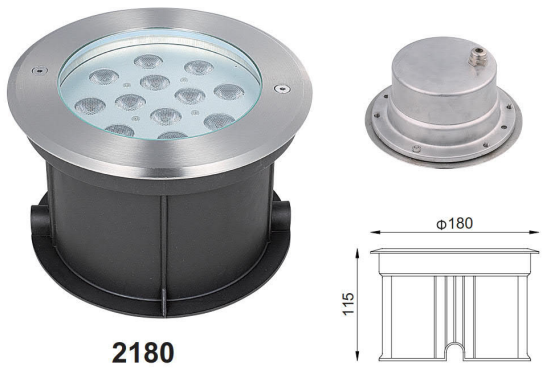

2180

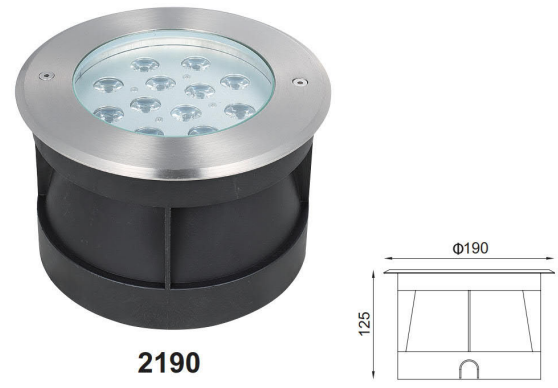

2190

技術參數 (Technical parameter)

適用光源 (Gpls)	LED
開孔尺寸 (Hole Size)	168
功率 (Power)	12W
鋁基板尺寸 (mm)	120
整箱數量 (Ctms)	18
包裝尺寸 (Box size cm)	56*38*44
淨重 kg	1.4KG

技術參數 (Technical parameter)

適用光源 (Gpls)	LED
開孔尺寸 (Hole Size)	175
功率 (Power)	12W
鋁基板尺寸 (mm)	120
整箱數量 (Ctms)	12
包裝尺寸 (Box size cm)	56*38*44
淨重 kg	1.45KG



2210



2240

技術參數 (Technical parameter)

適用光源 (Gpls)	LED
開孔尺寸 (Hole Size)	196
功率 (Power)	15W
鋁基板尺寸 (mm)	141
整箱數量 (Ctms)	12
包裝尺寸 (Box size cm)	47*47*50
淨重 kg	1.8KG

技術參數 (Technical parameter)

適用光源 (Gpls)	LED
開孔尺寸 (Hole Size)	225
功率 (Power)	18W
鋁基板尺寸 (mm)	165
整箱數量 (Ctms)	8
包裝尺寸 (Box size cm)	52*52*35
淨重 kg	2.4KG



2260

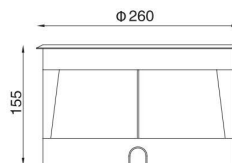

技術參數 (Technical parameter)

適用光源 (Gpls)	LED
開孔尺寸 (Hole Size)	245
功率 (Power)	24W
鋁基板尺寸 (mm)	183-188
整箱數量 (Ctms)	6
包裝尺寸 (Box size cm)	54*54*38
淨重 kg	2.75KG

產品說明

- 特點：燈具堅固的結構和嚴格的工藝制造流程，安全性高，使用壽命長，低碳節能
- 燈具材質：304 不銹鋼、塑料預埋件、高透光性鋼化玻璃、抗老化硅膠密封圈
- 防水等級：IP68
- 環境溫度：-20℃—+45℃
- 控制方式：單控、七彩內控、七彩外控、DMX512 控制
- 可選顏色：紅、黃、綠、藍、紫、白、暖白、七彩
- 安裝方式：嵌入式

Product description

- Characteristics: lamp of solid structure and strict manufacturing process technology, high safety, long service life, low carbon energy saving;
- Lamp of material: 304 stainless steel, plastic Embedded part, high transparent toughened glass, anti-aging silicone seal
- Waterproof level: IP68
- Environment temperature: -20℃—+45℃
- Control mode: single control, multicolor, multicolor external control, DMX512 control of internal control
- Optional colors: red, yellow, green, blue, purple, white, warm white, multicolor



2300

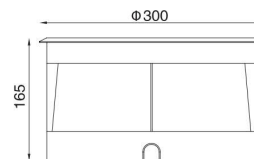

技術參數 (Technical parameter)

適用光源 (Gpls)	LED
開孔尺寸 (Hole Size)	280
功率 (Power)	36W
鋁基板尺寸 (mm)	235
整箱數量 (Ctms)	4
包裝尺寸 (Box size cm)	62*32*38
淨重 kg	3.5KG



LED 水下埋地燈系列

LED underwater buried lamp series

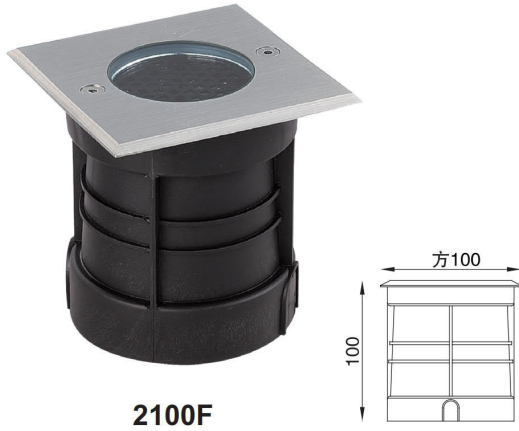

2100F

技術參數 (Technical parameter)

適用光源 (Gpls)	LED/MR16
開孔尺寸 (Hole Size)	90
功率 (Power)	3W/35W
鋁基板尺寸 (mm)	53
整箱數量 (Ctms)	48
包裝尺寸 (Box size cm)	45*45*38
淨重 kg	0.6KG



2120F

技術參數 (Technical parameter)

適用光源 (Gpls)	LED/MR16
開孔尺寸 (Hole Size)	102
功率 (Power)	3W/35W
鋁基板尺寸 (mm)	58
整箱數量 (Ctms)	24
包裝尺寸 (Box size cm)	55*42*32
淨重 kg	0.75KG



2150F

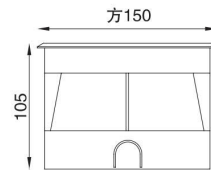

技術參數 (Technical parameter)

適用光源 (Gpls)	LED
開孔尺寸 (Hole Size)	140
功率 (Power)	6-9W
鋁基板尺寸 (mm)	98
整箱數量 (Ctms)	27
包裝尺寸 (Box size cm)	51*51*39
淨重 kg	1.2KG



2150 散热

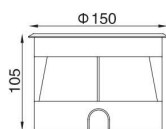

技術參數 (Technical parameter)

適用光源 (Gpls)	LED
開孔尺寸 (Hole Size)	140
功率 (Power)	6-9W
鋁基板尺寸 (mm)	98MM
整箱數量 (Ctms)	27
包裝尺寸 (Box size cm)	51*51*39
淨重 kg	1.25KG



2180 散热

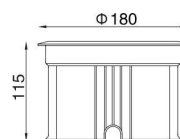

技術參數 (Technical parameter)

適用光源 (Gpls)	LED
開孔尺寸 (Hole Size)	168
功率 (Power)	12-15W
鋁基板尺寸 (mm)	120
整箱數量 (Ctms)	18
包裝尺寸 (Box size cm)	56*38*44
淨重 kg	1.75KG



2190 散热

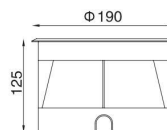

技術參數 (Technical parameter)

適用光源 (Gpls)	LED
開孔尺寸 (Hole Size)	175
功率 (Power)	12-15W
鋁基板尺寸 (mm)	120
整箱數量 (Ctms)	12
包裝尺寸 (Box size cm)	56*38*44
淨重 kg	1.9KG

LED 水下埋地燈系列

LED underwater buried lamp series



2210 散热

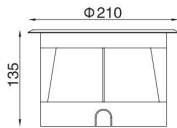

技術參數 (Technical parameter)

適用光源 (Gpls)	LED
開孔尺寸 (Hole Size)	196
功率 (Power)	15-18W
鋁基板尺寸 (mm)	141
整箱數量 (Ctms)	12
包裝尺寸 (Box size cm)	47*47*50
淨重 kg	2.4KG



2240 散热

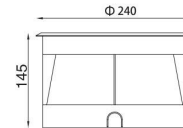

技術參數 (Technical parameter)

適用光源 (Gpls)	LED
開孔尺寸 (Hole Size)	225
功率 (Power)	18-24W
鋁基板尺寸 (mm)	165
整箱數量 (Ctms)	8
包裝尺寸 (Box size cm)	52*52*35
淨重 kg	3.2KG



2260 散热

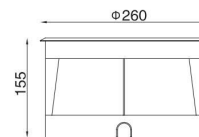

技術參數 (Technical parameter)

適用光源 (Gpls)	LED
開孔尺寸 (Hole Size)	245
功率 (Power)	24-36W
鋁基板尺寸 (mm)	183-188
整箱數量 (Ctms)	6
包裝尺寸 (Box size cm)	54*54*38
淨重 kg	3.7KG





2300 散热

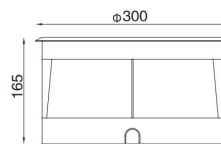

技術參數 (Technical parameter)

適用光源 (Gpls)	LED
開孔尺寸 (Hole Size)	280
功率 (Power)	48W
鋁基板尺寸 (mm)	235
整箱數量 (Ctms)	4
包裝尺寸 (Box size cm)	62*32*38
淨重 kg	5.8KG

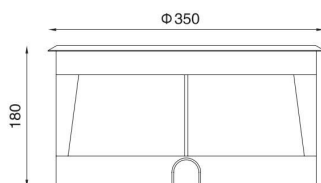

2350 散热

技術參數 (Technical parameter)

適用光源 (Gpls)	LED
開孔尺寸 (Hole Size)	330
功率 (Power)	60W
鋁基板尺寸 (mm)	270
整箱數量 (Ctms)	2
包裝尺寸 (Box size cm)	36*36*38
淨重 kg	10.7KG



長條水下地埋燈



技術參數 (Technical parameter)

適用光源 (Gpls)	LED	LED
產品尺寸 (Product Size)	L600*W95*H95 mm	L1000*W95*H95 mm
開孔尺寸 (Hole Size)	L565*W85*H90 mm	L965*W85*H90 mm
功率 (Power)	9-12 W	18/24/36 W
整箱數量 (Ctms)	6 pcs	4 pcs
包裝尺寸 (Box size)	64*43*25 cm	120*27*25 cm
淨重 (kg)	4 kg	6.6 kg

長條水下燈



技術參數 (Technical parameter)

適用光源 (Gpls)	LED	LED
產品尺寸 (Product Size)	L600*W95*H115 mm	L1000*W95*H115 mm
功率 (Power)	9-12 W	18/24/36 W
整箱數量 (Ctms)	6 pcs	4 pcs
包裝尺寸 (Box size)	64*43*25 cm	120*27*25 cm
淨重 (kg)	4 kg	6.6 kg



2015G

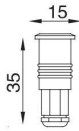

技術參數 (Technical parameter)

適用光源 (Gpls)	LED
開孔尺寸 (Hole Size)	13
功率 (Power)	0.1W
鋁基板尺寸 (mm)	8
整箱數量 (Ctms)	100
包裝尺寸 (Box size cm)	30.5*30.5*18
淨重 kg	0.05KG



2025G

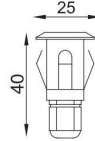

技術參數 (Technical parameter)

適用光源 (Gpls)	LED
開孔尺寸 (Hole Size)	18
功率 (Power)	0.2W
鋁基板尺寸 (mm)	10
整箱數量 (Ctms)	100
包裝尺寸 (Box size cm)	30.5*30.5*18
淨重 kg	0.1KG

產品說明

- 特點：燈具堅固的結構和嚴格的工藝製造流程，安全性高，使用壽命長，低碳節能
- 燈具材質：304 不銹鋼、塑料預埋件、高透光性鋼化玻璃、抗老化硅膠密封圈
- 防水等級：IP68
- 環境溫度：-20℃—+45℃
- 控制方式：單控、七彩內控、七彩外控、DMX512 控制
- 可選顏色：紅、黃、綠、藍、紫、白、暖白、七彩
- 安裝方式：嵌入式

Product description

- Characteristics: lamp of solid structure and strict manufacturing process technology, high safety, long service life, low carbon energy saving;
- Lamp of material: 304 stainless steel, plastic Embedded part, high transparent toughened glass, anti-aging silicone seal
- Waterproof level: IP68
- Environment temperature: -20℃—+45℃
- Control mode: single control, multicolor, multicolor external control, DMX512 control of internal control
- Optional colors: red, yellow, green, blue, purple, white, warm white, multicolor



2030G

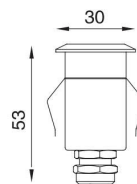

技術參數 (Technical parameter)

適用光源 (Gpls)	LED
開孔尺寸 (Hole Size)	25
功率 (Power)	0.6W
鋁基板尺寸 (mm)	12
整箱數量 (Ctms)	50
包裝尺寸 (Box size cm)	30.5*30.5*18
淨重 kg	0.2KG



2042G

技術參數 (Technical parameter)

適用光源 (Gpls)	LED
開孔尺寸 (Hole Size)	40
功率 (Power)	1W
鋁基板尺寸 (mm)	19
整箱數量 (Ctms)	50
包裝尺寸 (Box size cm)	30.5*30.5*18
淨重 kg	0.2KG



2052G

技術參數 (Technical parameter)

適用光源 (Gpls)	LED
開孔尺寸 (Hole Size)	48
功率 (Power)	1-2W
鋁基板尺寸 (mm)	25
整箱數量 (Ctms)	50
包裝尺寸 (Box size cm)	33.5*33.5*21.5
淨重 kg	0.25KG

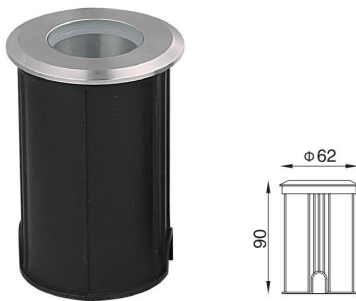

2062G

技術參數 (Technical parameter)

適用光源 (Gpls)	LED
開孔尺寸 (Hole Size)	55
功率 (Power)	1-2W
鋁基板尺寸 (mm)	34
整箱數量 (Ctms)	50
包裝尺寸 (Box size cm)	36*36*23
淨重 kg	0.35KG



2092G

技術參數 (Technical parameter)

適用光源 (Gpls)	LED
開孔尺寸 (Hole Size)	87
功率 (Power)	3W
鋁基板尺寸 (mm)	53
整箱數量 (Ctms)	20
包裝尺寸 (Box size cm)	51.5*21.5*28.5
淨重 kg	0.9KG

LED 水下埋地燈系列
LED underwater buried lamp series



2075G

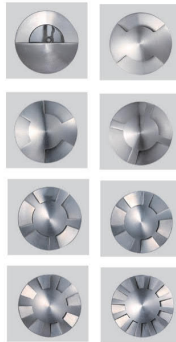
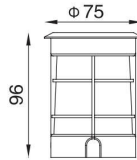

技術參數 (Technical parameter)

適用光源 (Gpls)	LED/COB
開孔尺寸 (Hole Size)	65
功率 (Power)	3W/COB 5W
鋁基板尺寸 (mm)	50
整箱數量 (Ctms)	45
包裝尺寸 (Box size cm)	42.5*25.5*26
淨重 kg	0.6KG



2110G

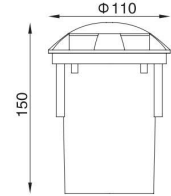

技術參數 (Technical parameter)

適用光源 (Gpls)	LED
開孔尺寸 (Hole Size)	105
功率 (Power)	3W
鋁基板尺寸 (mm)	68
整箱數量 (Ctms)	20
包裝尺寸 (Box size cm)	58*24*35.5
淨重 kg	1.1KG



2092CREE

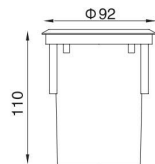

技術參數 (Technical parameter)

適用光源 (Gpls)	COB
開孔尺寸 (Hole Size)	87
功率 (Power)	3W
透鏡角度 (Angle)	4°
整箱數量 (Ctms)	20
包裝尺寸 (Box size cm)	51.5*21.5*28.5
淨重 kg	0.9KG



2042CREE

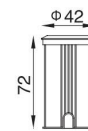

技術參數 (Technical parameter)

適用光源 (Gpls)	COB
開孔尺寸 (Hole Size)	38
功率 (Power)	1W
透鏡角度 (Angle)	4°
整箱數量 (Ctms)	50
包裝尺寸 (Box size cm)	30.5*30.5*18
淨重 kg	0.2KG



LED 埋地燈系列

LED Underwater lamp series

產品說明

- 特點：燈具堅固的結構和嚴格的工藝製造流程，安全性高，使用壽命長，低碳節能
- 燈具材質：304 不銹鋼、塑料預埋件、高透光性鋼化玻璃、抗老化硅膠密封圈
- 防水等級：IP68
- 環境溫度：-20°C—+45°C
- 控制方式：單控、七彩內控、七彩外控、DMX512 控制
- 可選顏色：紅、黃、綠、藍、紫、白、暖白、七彩
- 安裝方式：嵌入式

Product description

- Characteristics: lamp of solid structure and strict manufacturing process technology, high safety, long service life, low carbon energy saving;
- Lamp of material: 304 stainless steel, plastic Embedded part, high transparent toughened glass, anti-aging silicone seal
- Waterproof level: IP68
- Environment temperature: -20°C—+45°C
- Control mode: single control, multicolor, multicolor external control, DMX512 control of internal control
- Optional colors: red, yellow, green, blue, purple, white, warm white, multicolor

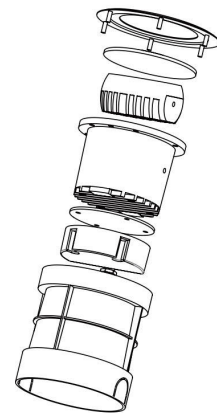

LED 埋地燈結構圖

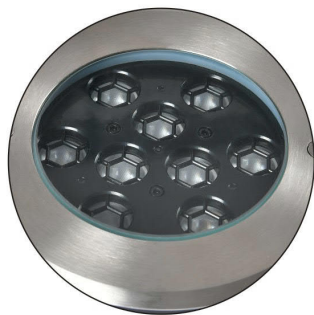

3100B

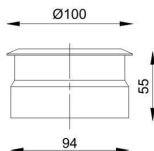

技術參數 (Technical parameter)

適用光源 (Gplis)	LED
開孔尺寸 (Hole Size)	95 mm
功率 (Power)	3*1W
鋁基板尺寸 (Aluminum substrate size)	55 mm
整箱數量 (Ctms)	48 pcs
包裝尺寸 (Box size cm)	43*43*24.5 cm
淨重 (kg)	0.5 kg



3130B

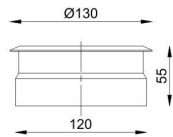

技術參數 (Technical parameter)

適用光源 (Gpls)	LED
開孔尺寸 (Hole Size)	122 mm
功率 (Power)	6*1W
鋁基板尺寸 (Aluminum substrate size)	76 mm
整箱數量 (Ctms)	30 pcs
包裝尺寸 (Box size cm)	40.5*27.5*35 cm
淨重 (kg)	0.7 kg



3150B

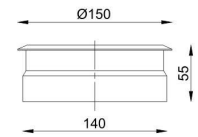

技術參數 (Technical parameter)

適用光源 (Gpls)	LED
開孔尺寸 (Hole Size)	142 mm
功率 (Power)	9*1W
鋁基板尺寸 (Aluminum substrate size)	96 mm
整箱數量 (Ctms)	27 pcs
包裝尺寸 (Box size cm)	47.5*47.5*21.5 cm
淨重 (kg)	0.9 kg



3190B

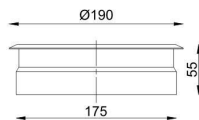

技術參數 (Technical parameter)

適用光源 (Gpls)	LED
開孔尺寸 (Hole Size)	175 mm
功率 (Power)	12*1W
鋁基板尺寸 (Aluminum substrate size)	120 mm
整箱數量 (Ctms)	20 pcs
包裝尺寸 (Box size cm)	39.5*39.5*35 cm
淨重 (kg)	1.3 kg



3210B

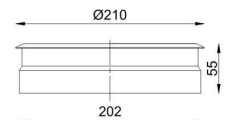

技術參數 (Technical parameter)

適用光源 (Gpls)	LED
開孔尺寸 (Hole Size)	203 mm
功率 (Power)	18*1W
鋁基板尺寸 (Aluminum substrate size)	142 mm
整箱數量 (Ctms)	12 pcs
包裝尺寸 (Box size cm)	44*44*21.5 cm
淨重 (kg)	1.7 kg

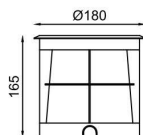

技術參數 (Technical parameter)

適用光源 (Gplis)	COB
開孔尺寸 (Hole Size)	175 mm
功率 (Power)	15W
整箱數量 (Ctms)	8 pcs
包裝尺寸 (Box size cm)	39*39*36 cm
淨重 (kg)	2 kg

3180MT-COB



3180MT-LED

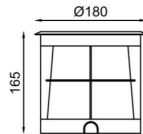

技術參數 (Technical parameter)

適用光源 (Gpls)	LED
開孔尺寸 (Hole Size)	175 mm
功率 (Power)	6/9/12 W
鋁基板尺寸 (Aluminum substrate size)	98 mm
整箱數量 (Ctms)	8 pcs
包裝尺寸 (Box size cm)	39*39*36 cm
淨重 (kg)	2.1 kg



3210MT

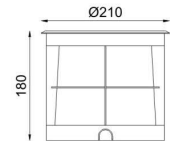

技術參數 (Technical parameter)

適用光源 (Gpls)	LED
開孔尺寸 (Hole Size)	195 mm
功率 (Power)	12/15 W
鋁基板尺寸 (Aluminum substrate size)	120 mm
整箱數量 (Ctms)	6 Pcs
包裝尺寸 (Box size cm)	67*23.5*39 cm
淨重 (kg)	3 kg



3260MT

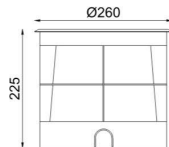

技術參數 (Technical parameter)

適用光源 (Gpls)	LED
開孔尺寸 (Hole Size)	245 mm
功率 (Power)	18/24 W
鋁基板尺寸 (Aluminum substrate size)	156 mm
整箱數量 (Ctms)	4 Pcs
包裝尺寸 (Box size cm)	54*28*48 cm
淨重 (kg)	5.1 kg



3320MT

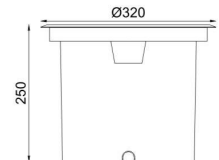

技術參數 (Technical parameter)

適用光源 (Gpls)	LED
開孔尺寸 (Hole Size)	305 mm
功率 (Power)	36 W
鋁基板尺寸 (Aluminum substrate size)	215 mm
整箱數量 (Ctms)	4 Pcs
包裝尺寸 (Box size cm)	67*34.5*51 cm
淨重 (kg)	7 kg



3100B-2

技術參數 (Technical parameter)

適用光源 (Gpls)	LED
開孔尺寸 (Hole Size)	92 mm
功率 (Power)	3-5 W
鋁基板尺寸 (Aluminum substrate size)	53 mm
整箱數量 (Ctms)	24 Pcs
包裝尺寸 (Box size cm)	42.5*22.5*26 cm
淨重 (kg)	0.4 kg

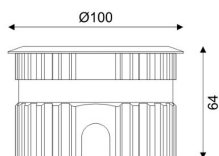



3085 LED



3100 LED

技術參數 (Technical parameter)

適用光源 (Gpls)	LED
開孔尺寸 (Hole Size)	80
功率 (Power)	3W
鋁基板尺寸 (mm)	45MM
整箱數量 (Ctms)	30
包裝尺寸 (Box size cm)	56*34*25
淨重 kg	0.6KG

技術參數 (Technical parameter)

適用光源 (Gpls)	LED
開孔尺寸 (Hole Size)	90
功率 (Power)	3W
鋁基板尺寸 (mm)	58
整箱數量 (Ctms)	30
包裝尺寸 (Box size cm)	56*34*25
淨重 kg	0.75KG



3130 LED

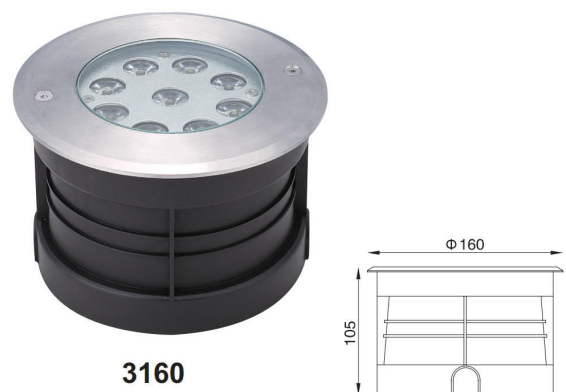

3160

技術參數 (Technical parameter)

適用光源 (Gpls)	LED
開孔尺寸 (Hole Size)	120
功率 (Power)	6W
鋁基板尺寸 (mm)	81
整箱數量 (Ctms)	24
包裝尺寸 (Box size cm)	43*29*36
淨重 kg	1.1KG

技術參數 (Technical parameter)

適用光源 (Gpls)	LED/COB
開孔尺寸 (Hole Size)	145
功率 (Power)	6-9W/COB10W
鋁基板尺寸 (mm)	104
整箱數量 (Ctms)	12
包裝尺寸 (Box size cm)	52*36*26
淨重 kg	1.8KG



3180



3210

技術參數 (Technical parameter)

適用光源 (Gpls)	LED
開孔尺寸 (Hole Size)	170
功率 (Power)	12W
鋁基板尺寸 (mm)	114
整箱數量 (Ctms)	8
包裝尺寸 (Box size cm)	39*39*28.5
淨重 kg	2.0KG

技術參數 (Technical parameter)

適用光源 (Gpls)	LED
開孔尺寸 (Hole Size)	200
功率 (Power)	15-18W
鋁基板尺寸 (mm)	134
整箱數量 (Ctms)	8
包裝尺寸 (Box size cm)	45*45*28
淨重 kg	2.74KG



3230

技術參數 (Technical parameter)

適用光源 (Gpls)	LED
開孔尺寸 (Hole Size)	220
功率 (Power)	18-24W
鋁基板尺寸 (mm)	156
整箱數量 (Ctms)	6
包裝尺寸 (Box size cm)	48.5*25*45
淨重 kg	3.3KG



3260

技術參數 (Technical parameter)

適用光源 (Gpls)	LED
開孔尺寸 (Hole Size)	240
功率 (Power)	24W
鋁基板尺寸 (mm)	183-188
整箱數量 (Ctms)	6
包裝尺寸 (Box size cm)	54*28*42
淨重 kg	4.2KG

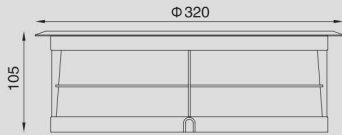

技術參數 (Technical parameter)

適用光源 (Gpls)	LED
開孔尺寸 (Hole Size)	295
功率 (Power)	36W
鋁基板尺寸 (mm)	235
整箱數量 (Ctms)	4
包裝尺寸 (Box size cm)	67*35*24.5
淨重 kg	5.9KG



3320



3300 散熱

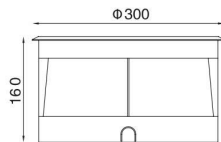

3350 散熱

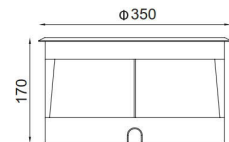

技術參數 (Technical parameter)

適用光源 (Gpls)	LED
開孔尺寸 (Hole Size)	285
功率 (Power)	36W
鋁基板尺寸 (mm)	220
整箱數量 (Ctms)	4
包裝尺寸 (Box size cm)	62*33*35
淨重 kg	4.5KG

技術參數 (Technical parameter)

適用光源 (Gpls)	LED
開孔尺寸 (Hole Size)	330
功率 (Power)	60W
鋁基板尺寸 (mm)	265
整箱數量 (Ctms)	2
包裝尺寸 (Box size cm)	38*38*40
淨重 kg	6.9KG

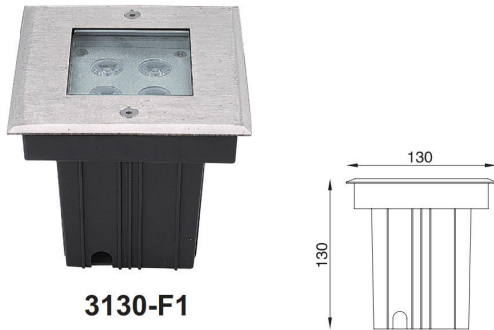

3130-F1

技術參數 (Technical parameter)

適用光源 (Gpls)	LED/COB
開孔尺寸 (Hole Size)	120
功率 (Power)	4W/COB5W
鋁基板尺寸 (mm)	70*70
整箱數量 (Ctms)	18
包裝尺寸 (Box size cm)	44*29*30
淨重 kg	1.22KG



3170-F1

技術參數 (Technical parameter)

適用光源 (Gpls)	LED/COB
開孔尺寸 (Hole Size)	155
功率 (Power)	9W/COB10W
鋁基板尺寸 (mm)	95*95
整箱數量 (Ctms)	12
包裝尺寸 (Box size cm)	44*29*30
淨重 kg	2.0KG



3210-F1

3210-F1COB

技術參數 (Technical parameter)

適用光源 (Gpls)	LED/COB
開孔尺寸 (Hole Size)	195
功率 (Power)	16W/COB20W
鋁基板尺寸 (mm)	195*195
整箱數量 (Ctms)	8
包裝尺寸 (Box size cm)	45.5*45.5*30
淨重 kg	3.0Kg



3260-F1

技術參數 (Technical parameter)

適用光源 (Gpls)	LED/COB
開孔尺寸 (Hole Size)	245
功率 (Power)	36W
鋁基板尺寸 (mm)	190*190
整箱數量 (Ctms)	4
包裝尺寸 (Box size cm)	52*28*35
淨重 kg	5.8Kg



3100COB 高筒

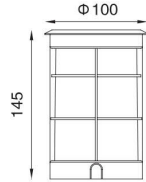

技術參數 (Technical parameter)

適用光源 (Gpls)	COB
開孔尺寸 (Hole Size)	90
功率 (Power)	7W
整箱數量 (Ctms)	20
包裝尺寸 (Box size cm)	56*23*25
淨重 kg	0.9KG



3120COB

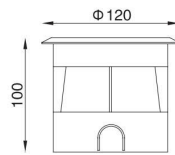

技術參數 (Technical parameter)

適用光源 (Gpls)	COB
開孔尺寸 (Hole Size)	105
功率 (Power)	5-7W
整箱數量 (Ctms)	18
包裝尺寸 (Box size cm)	43*29*36
淨重 kg	0.85KG

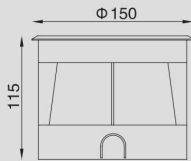

技術參數 (Technical parameter)

適用光源 (Gpls)	COB
開孔尺寸 (Hole Size)	135
功率 (Power)	10W
整箱數量 (Ctms)	12
包裝尺寸 (Box size cm)	52*35.5*26.5
淨重 kg	1.44KG



3150COB



3180COB

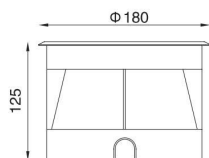

技術參數 (Technical parameter)

適用光源 (Gpls)	COB
開孔尺寸 (Hole Size)	170
功率 (Power)	15W
整箱數量 (Ctms)	8
包裝尺寸 (Box size cm)	39*39*28
淨重 kg	2.0KG



3260COB

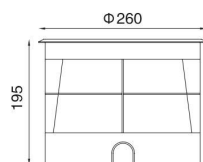

技術參數 (Technical parameter)

適用光源 (Gpls)	COB
開孔尺寸 (Hole Size)	245
功率 (Power)	40W
整箱數量 (Ctms)	4
包裝尺寸 (Box size cm)	53*27*42
淨重 kg	4.1KG



3120P

技術參數 (Technical parameter)

適用光源 (Gpls)	LED
開孔尺寸 (Hole Size)	105
功率 (Power)	1x3W
整箱數量 (Ctms)	18
包裝尺寸 (Box size cm)	43*29*36
淨重 kg	0.85KG



3150P

技術參數 (Technical parameter)

適用光源 (Gpls)	COB
開孔尺寸 (Hole Size)	135
功率 (Power)	7W COB
整箱數量 (Ctms)	12
包裝尺寸 (Box size cm)	52*35.5*26.5
淨重 kg	1.44KG

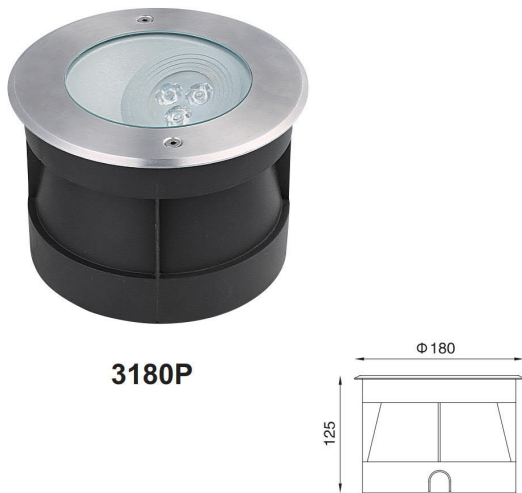

3180P

技術參數 (Technical parameter)

適用光源 (Gpls)	LED
開孔尺寸 (Hole Size)	170
功率 (Power)	3x3W
整箱數量 (Ctms)	8
包裝尺寸 (Box size cm)	39*39*28
淨重 kg	2.0KG

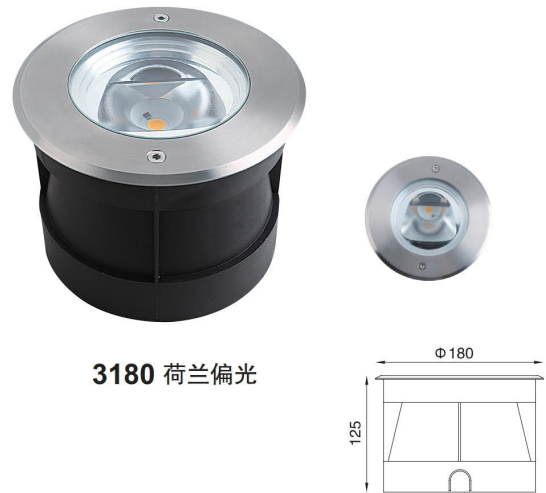

3180 荷兰偏光

技術參數 (Technical parameter)

適用光源 (Gpls)	COB
開孔尺寸 (Hole Size)	170
功率 (Power)	COB15W
整箱數量 (Ctms)	8
包裝尺寸 (Box size cm)	39*39*28
淨重 kg	2.05KG



3130P

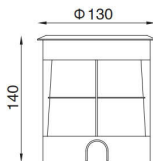

技術參數 (Technical parameter)

適用光源 (Gpls)	COB
開孔尺寸 (Hole Size)	120
功率 (Power)	7W
整箱數量 (Ctms)	18
包裝尺寸 (Box size cm)	43*43*34
淨重 kg	1.2KG



3160P

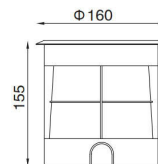

技術參數 (Technical parameter)

適用光源 (Gpls)	COB
開孔尺寸 (Hole Size)	145
功率 (Power)	12-15W
整箱數量 (Ctms)	12
包裝尺寸 (Box size cm)	51*36*35
淨重 kg	1.9KG



3270P

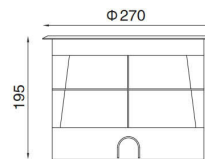

技術參數 (Technical parameter)

適用光源 (Gpls)	COB
開孔尺寸 (Hole Size)	245
功率 (Power)	30-40W
整箱數量 (Ctms)	4
包裝尺寸 (Box size cm)	54*28*42.5
淨重 kg	5.7KG



3130 COB 外调光



3130 LED 外调光

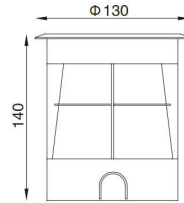

技術參數 (Technical parameter)

適用光源 (Gpls)	LED/COB
開孔尺寸 (Hole Size)	115
功率 (Power)	3W/COB7W
鋁基板尺寸 (mm)	55
整箱數量 (Ctms)	18
包裝尺寸 (Box size cm)	43*43*34
淨重 kg	1.2KG



3160 LED 外调光



3160 COB 外调光

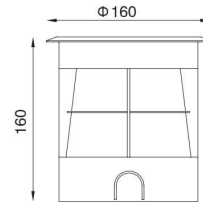

技術參數 (Technical parameter)

適用光源 (Gpls)	LED/COB
開孔尺寸 (Hole Size)	148
功率 (Power)	9W/COB15W
鋁基板尺寸 (mm)	86
整箱數量 (Ctms)	12
包裝尺寸 (Box size cm)	51*36*35
淨重 kg	1.9KG



3260 LED 外调光

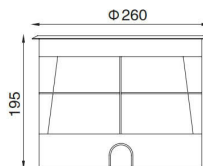

技術參數 (Technical parameter)

適用光源 (Gpls)	LED
開孔尺寸 (Hole Size)	245
功率 (Power)	18-24W
鋁基板尺寸 (mm)	156
整箱數量 (Ctms)	4
包裝尺寸 (Box size cm)	53*30*44
淨重 kg	5.1KG



3130A

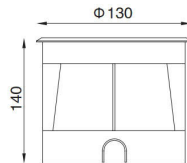

技術參數 (Technical parameter)

光源品牌 (Gpls)	CREE
開孔尺寸 (Hole Size)	120
功率 (Power)	3x2W
透鏡角度 (Angle)	6°
整箱數量 (Ctms)	12
包裝尺寸 (Box size cm)	43*29*32
淨重 kg	1.3KG



3160A

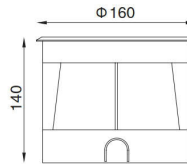

技術參數 (Technical parameter)

光源品牌 (Gpls)	CREE
開孔尺寸 (Hole Size)	145
功率 (Power)	6x2W
透鏡角度 (Angle)	6°
整箱數量 (Ctms)	12
包裝尺寸 (Box size cm)	52*36*32
淨重 kg	1.8KG



3180A

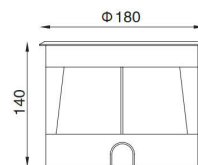

技術參數 (Technical parameter)

光源品牌 (Gpls)	CREE
開孔尺寸 (Hole Size)	166
功率 (Power)	9x2W
透鏡角度 (Angle)	6°
整箱數量 (Ctms)	8
包裝尺寸 (Box size cm)	40*40*30
淨重 kg	2.3KG



3210A

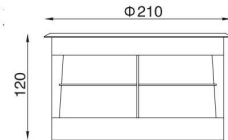

技術參數 (Technical parameter)

光源品牌 (Gpls)	CREE
開孔尺寸 (Hole Size)	200
功率 (Power)	12x2W
透鏡角度 (Angle)	6°
整箱數量 (Ctms)	8
包裝尺寸 (Box size cm)	45*45*28
淨重 kg	2.7KG



3260A

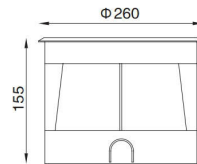

技術參數 (Technical parameter)

光源品牌 (Gpls)	CREE
開孔尺寸 (Hole Size)	240
功率 (Power)	18x2W
透鏡角度 (Angle)	6°
整箱數量 (Ctms)	4
包裝尺寸 (Box size cm)	54*28*33
淨重 kg	5.3KG



3290A

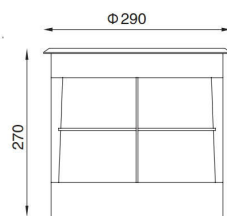

技術參數 (Technical parameter)

光源品牌 (Gpls)	CREE
開孔尺寸 (Hole Size)	270
功率 (Power)	27x3W
透鏡角度 (Angle)	6°
整箱數量 (Ctms)	1
包裝尺寸 (Box size cm)	33.5*33.5*33.5
淨重 kg	9KG



3210 12W 调光 **3210 COB 调光**

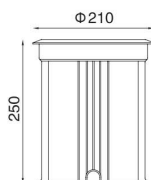

3210CREE-9W

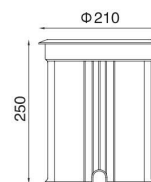

技術參數 (Technical parameter)

適用光源 (Gpls)	LED
開孔尺寸 (Hole Size)	200
功率 (Power)	12W/COB20W
鋁基板尺寸 (mm)	101
整箱數量 (Ctms)	6
包裝尺寸 (Box size cm)	67*45*31
淨重 kg	3.1KG

技術參數 (Technical parameter)

適用光源 (Gpls)	LED
開孔尺寸 (Hole Size)	200
功率 (Power)	9W
鋁基板尺寸 (mm)	工廠標配
整箱數量 (Ctms)	6
包裝尺寸 (Box size cm)	67*45*31
淨重 kg	3.1KG



3230CREE-12W

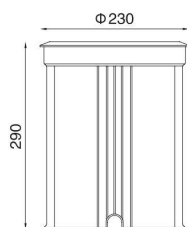

3230 15W LED 调光

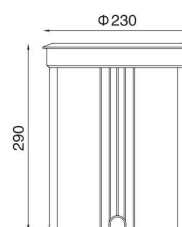

技術參數 (Technical parameter)

適用光源 (Gpls)	LED
開孔尺寸 (Hole Size)	220
功率 (Power)	12W
鋁基板尺寸 (mm)	工廠標配
整箱數量 (Ctms)	6
包裝尺寸 (Box size cm)	71*48*32
淨重 kg	3.4KG

技術參數 (Technical parameter)

適用光源 (Gpls)	LED
開孔尺寸 (Hole Size)	220
功率 (Power)	15W
鋁基板尺寸 (mm)	工廠標配
整箱數量 (Ctms)	6
包裝尺寸 (Box size cm)	71*48*32
淨重 kg	3.8KG



3250 牛眼可伸縮

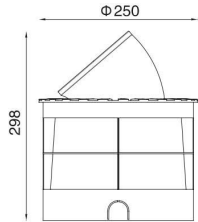

3250 牛眼投射燈

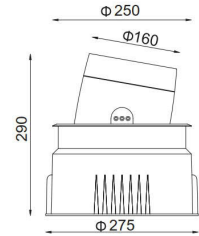

技術參數 (Technical parameter)

適用光源 (Gpls)	COB
開孔尺寸 (Hole Size)	245
功率 (Power)	20W
整箱數量 (Ctms)	4
包裝尺寸 (Box size cm)	53*30*44
淨重 kg	4.3KG

技術參數 (Technical parameter)

適用光源 (Gpls)	LED
開孔尺寸 (Hole Size)	245
功率 (Power)	15-24W
鋁基板尺寸 (mm)	140
整箱數量 (Ctms)	4
包裝尺寸 (Box size cm)	58*30*64
淨重 kg	4.2KG



技術參數 (Technical parameter)

適用光源 (Gpls)	COB
開孔尺寸 (Hole Size)	210
功率 (Power)	30W
整箱數量 (Ctms)	6
包裝尺寸 (Box size cm)	48.5*25*45
淨重 kg	2.6KG



3215 牛眼 CREE30W

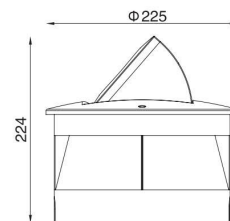



3110-1T 散热



3110-2T 散热

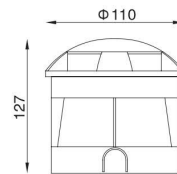

3110-3T 散热



3110-4T 散热

技術參數 (Technical parameter)

適用光源 (Gpls)	LED/3014 貼片
開孔尺寸 (Hole Size)	105
功率 (Power)	3W
鋁基板尺寸 (mm)	60
整箱數量 (Ctms)	12
包裝尺寸 (Box size cm)	46*32*33
淨重 kg	1.1KG

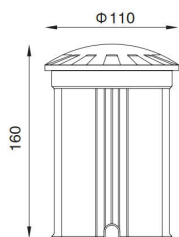

技術參數 (Technical parameter)

適用光源 (Gpls)	LED
開孔尺寸 (Hole Size)	105
功率 (Power)	3W
鋁基板尺寸 (mm)	65
整箱數量 (Ctms)	20
包裝尺寸 (Box size cm)	52*24*36
淨重 kg	0.85KG



3110-1T

LED 埋地燈系列

LED Underwater lamp series

技術參數 (Technical parameter)

適用光源 (Gpls)	LED
開孔尺寸 (Hole Size)	95
功率 (Power)	3W
鋁基板尺寸 (mm)	55
整箱數量 (Ctms)	30
包裝尺寸 (Box size cm)	56*34*25
淨重 kg	0.45KG

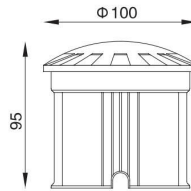

3100 全铝透光

技術參數 (Technical parameter)

適用光源 (Gpls)	LED
開孔尺寸 (Hole Size)	125
功率 (Power)	6W
鋁基板尺寸 (mm)	81
整箱數量 (Ctms)	12
包裝尺寸 (Box size cm)	44*29.5*30
淨重 kg	0.88KG

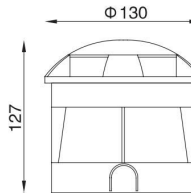

3130 全铝透光



3150 全铝透光

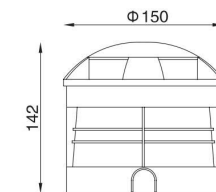

技術參數 (Technical parameter)

適用光源 (Gpls)	LED
開孔尺寸 (Hole Size)	145
功率 (Power)	9W
鋁基板尺寸 (mm)	104
整箱數量 (Ctms)	12
包裝尺寸 (Box size cm)	46*32*33
淨重 kg	1.1KG



技術參數 (Technical parameter)

適用光源 (Gpls)	COB
開孔尺寸 (Hole Size)	200
功率 (Power)	COB 10W
整箱數量 (Ctms)	6
包裝尺寸 (Box size cm)	63*50*25
淨重 kg	2.7KG



3210 COB 歪頭



3250 LED 歪頭

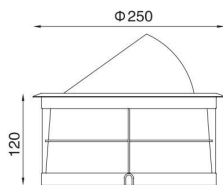

技術參數 (Technical parameter)

適用光源 (Gpls)	LED
開孔尺寸 (Hole Size)	245
功率 (Power)	7-9W
鋁基板尺寸 (mm)	100
整箱數量 (Ctms)	8
包裝尺寸 (Box size cm)	54*54*44.5
淨重 kg	2.77KG



3250 COB 歪頭

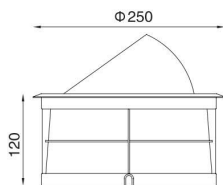

技術參數 (Technical parameter)

適用光源 (Gpls)	COB
開孔尺寸 (Hole Size)	245
功率 (Power)	12-15W
整箱數量 (Ctms)	6
包裝尺寸 (Box size cm)	80*28*46
淨重 kg	2.77KG

LED 埋地燈系列

LED Underwater lamp series



技術參數 (Technical parameter)

適用光源 (Gpls)	LED
開孔尺寸 (Hole Size)	明裝
功率 (Power)	3W
鋁基板尺寸 (mm)	55
整箱數量 (Ctms)	20
包裝尺寸 (Box size cm)	65*28*24
淨重 kg	1.2KG

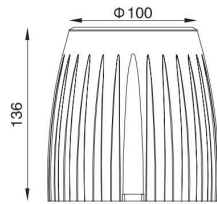

3100MZ



技術參數 (Technical parameter)

適用光源 (Gpls)	LED
開孔尺寸 (Hole Size)	明裝
功率 (Power)	9W
鋁基板尺寸 (mm)	104
整箱數量 (Ctms)	6
包裝尺寸 (Box size cm)	67*45*30.5
淨重 kg	2.24KG

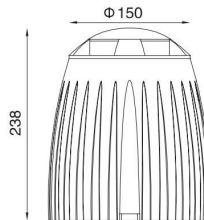

3150MZ



技術參數 (Technical parameter)

適用光源 (Gpls)	LED
開孔尺寸 (Hole Size)	明裝
功率 (Power)	9W
鋁基板尺寸 (mm)	104
整箱數量 (Ctms)	6
包裝尺寸 (Box size cm)	67*45*30.5
淨重 kg	2.24KG

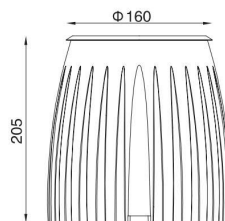

3160MZ



3210MZ

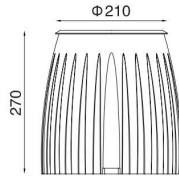

技術參數 (Technical parameter)

適用光源 (Gpls)	LED
開孔尺寸 (Hole Size)	明裝
功率 (Power)	18W
鋁基板尺寸 (mm)	134
整箱數量 (Ctms)	4
包裝尺寸 (Box size cm)	55*29*45
淨重 kg	6.0KG



3210MZ 透光

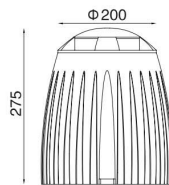

2T



4T

技術參數 (Technical parameter)

適用光源 (Gpls)	LED
開孔尺寸 (Hole Size)	明裝
功率 (Power)	18W
鋁基板尺寸 (mm)	134
整箱數量 (Ctms)	4
包裝尺寸 (Box size cm)	55*29*45
淨重 kg	6.0KG

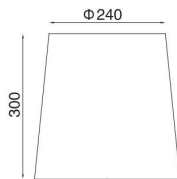

技術參數 (Technical parameter)

適用光源 (Gpls)	LED/G12
開孔尺寸 (Hole Size)	明裝
功率 (Power)	18W
鋁基板尺寸 (mm)	134
整箱數量 (Ctms)	1
包裝尺寸 (Box size cm)	31.5*31.5*31.5
淨重 kg	4.5KG



3245MZ-G12



3245MZ-15W

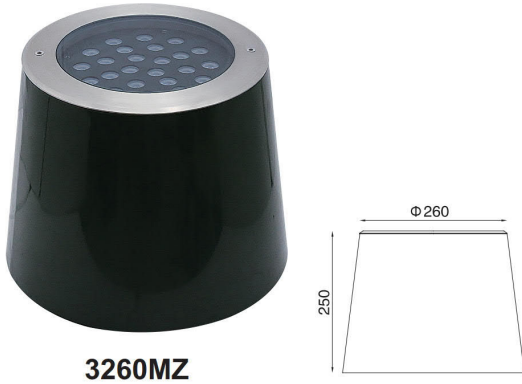

技術參數 (Technical parameter)

適用光源 (Gpls)	LED
開孔尺寸 (Hole Size)	明裝
功率 (Power)	24W
鋁基板尺寸 (mm)	183-188
整箱數量 (Ctms)	1
包裝尺寸 (Box size cm)	34*32*34
淨重 kg	5.8KG



技術參數 (Technical parameter)

適用光源 (Gpls)	LED
開孔尺寸 (Hole Size)	明裝
功率 (Power)	36W
鋁基板尺寸 (mm)	235
整箱數量 (Ctms)	1
包裝尺寸 (Box size cm)	40*40*32
淨重 kg	8.5KG

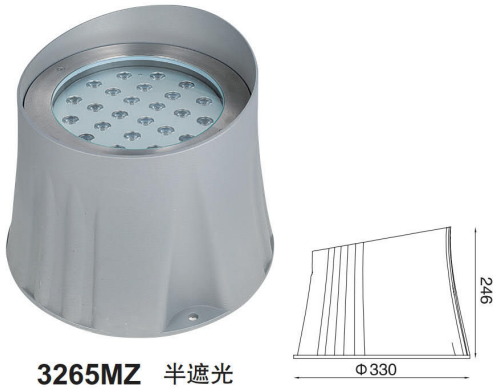

技術參數 (Technical parameter)

適用光源 (Gpls)	LED
開孔尺寸 (Hole Size)	明裝
功率 (Power)	24W
鋁基板尺寸 (mm)	183-188
整箱數量 (Ctms)	1
包裝尺寸 (Box size cm)	33*33*28
淨重 kg	4.8KG



技術參數 (Technical parameter)

適用光源 (Gpls)	LED
開孔尺寸 (Hole Size)	明裝
功率 (Power)	36W
鋁基板尺寸 (mm)	200
整箱數量 (Ctms)	1
包裝尺寸 (Box size cm)	30*30*35
淨重 kg	5.9KG

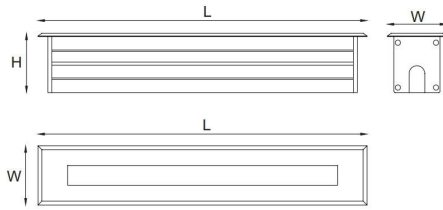

產品說明

- 特點：燈具堅固的結構和嚴格的工藝製造流程，安全性高，使用壽命長，低碳節能
- 燈具材質：不銹鋼面板、專用散熱燈體、高透光性鋼化玻璃、抗老化硅膠密封圈
- 防水等級：IP67
- 環境溫度：-20℃—+45℃
- 控制方式：單控、七彩內控
- 可選顏色：紅、黃、綠、藍、紫、白、暖白、七彩
- 安裝方式：嵌入式

Product description

- Characteristics: lamp of solid structure and strict manufacturing process technology, high safety, long service life, low carbon energy saving;
- Lamp of material: Stainless steel, dedicated radiator, high transparent toughened glass, anti-aging silicone seal
- Waterproof level: IP67
- Environment temperature: -20℃—+45℃
- Control mode: single control, multicolor internal control
- Optional colors: red, yellow, green, blue, purple, white, warm white, multicolor



技術參數 (Technical parameter)

適用光源 (Gpls)	LED	LED	LED	LED
產品尺寸 (Hole Size)	L300*H90*W90	L500*H90*W90	L600*H90*W90	L1000*H90*W90
開孔尺寸 (Hole Size)	285*80*110	485*80*110	595*80*110	985*80*110
功率 (Power)	6W	9W-12W	9W-12W	24W
整箱數量 (Ctms)	8	6	6	4
包裝尺寸 (Box size cm)	32*25*46	53*25*34	63*25*34	103.5*25*23
淨重 kg	2.4KG	3.8KG	4.4KG	6.3KG



3270 射燈

技術參數 (Technical parameter)

適用光源 (Gpls)	LED
功率 (Power)	27*3W
鋁基板尺寸 (mm)	工廠標配
整箱數量 (Ctms)	1
包裝尺寸 (Box size cm)	33.5*33.5*33.5
淨重 kg	9KG



3085 射燈

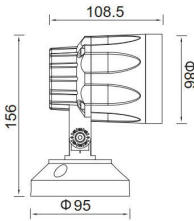

3085 斜口射燈

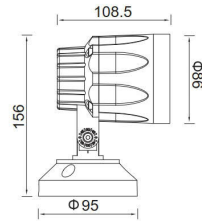

技術參數 (Technical parameter)

適用光源 (Gpls)	LED
功率 (Power)	3*3W
鋁基板尺寸 (mm)	工廠標配
淨重 kg	1.2KG

技術參數 (Technical parameter)

適用光源 (Gpls)	COB
功率 (Power)	10W
鋁基板尺寸 (mm)	
淨重 kg	1.2KG

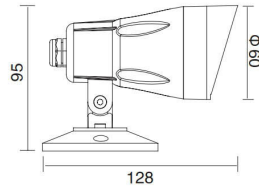

3060 斜口射灯

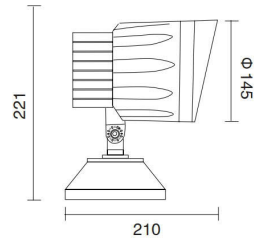

3140 射灯

技術參數 (Technical parameter)

適用光源 (Gpls)	LED/COB
功率 (Power)	5W
鋁基板尺寸 (mm)	工廠標配
淨重 kg	0.55KG

技術參數 (Technical parameter)

適用光源 (Gpls)	LED
功率 (Power)	9*3W
鋁基板尺寸 (mm)	工廠標配
淨重 kg	4.8KG

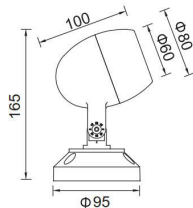

3060 蛋形射灯

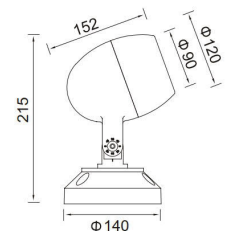

3090 蛋形射灯

技術參數 (Technical parameter)

適用光源 (Gpls)	LED
功率 (Power)	3*2W
鋁基板尺寸 (mm)	工廠標配
淨重 kg	0.75KG

技術參數 (Technical parameter)

適用光源 (Gpls)	LED
功率 (Power)	6*2w
鋁基板尺寸 (mm)	工廠標配
淨重 kg	1.85KG

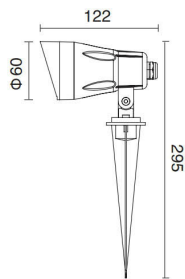

技術參數 (Technical parameter)

適用光源 (Gpls)	LED/COB
功率 (Power)	5W
鋁基板尺寸 (mm)	工廠標配
淨重 kg	0.55KG

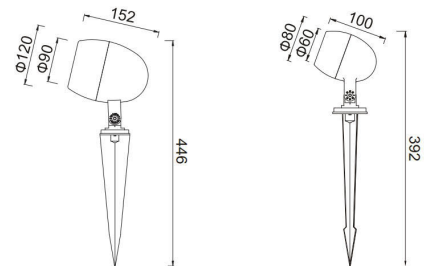

技術參數 (Technical parameter)

適用光源 (Gpls)	LED
功率 (Power)	3*2W
鋁基板尺寸 (mm)	工廠標配
淨重 kg	0.75KG

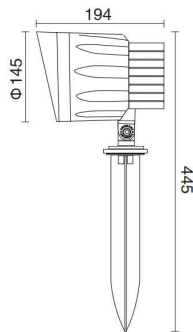

技術參數 (Technical parameter)

適用光源 (Gpls)	LED
功率 (Power)	9*3W
鋁基板尺寸 (mm)	工廠標配
淨重 kg	4.8KG

